

FUJITSU Storage ETERNUS LT140 Tape Library

Read Me First

Fujitsu would like to thank you for purchasing our FUJITSU Storage ETERNUS LT140 Tape Library (hereinafter referred to as "LT140").

Read this document and check the shipment package to confirm that no items are missing. Refer to the LT140 manuals that are listed in this document as necessary.

CAUTION



Read and understand the "Safety Precautions" before use.



"Safety Precautions"

The information in this document is subject to change without notice for improvement and functionality expansion of the LT140. The latest information about the LT140 is available at the following website:
<http://www.fujitsu.com/global/support/products/computing/storage/tape/>

Table of Contents

LT140 Manuals	2
Package Contents	3
Notes Regarding the Handling of Tape Cartridges	7
Related Constitutions	9



The company names and product names mentioned in this document are either registered trademarks or trademarks of their respective companies.

Copyright 2018 FUJITSU LIMITED

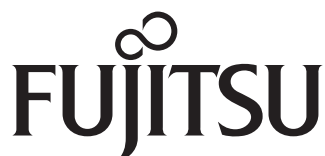

* P 3 A G - 3 6 9 2 - 0 1 E N *

LT140 Manuals

The manuals are available at the following website:

<http://www.fujitsu.com/global/support/products/computing/storage/tape/manuals/>

Manual Title	Manual Code	Description
FUJITSU Storage ETERNUS LT140 Tape Library Safety Precautions	P3AG-3682	Describes the safety precautions that must be taken for the LT140. A manual booklet is also provided.
FUJITSU Storage ETERNUS LT140 Tape Library Read Me First	P3AG-3692	Describes how the manuals are organized, package contents, and the terms of use for the LT140. A manual booklet is also provided.
FUJITSU Storage ETERNUS LT140 Tape Library Overview	P3AG-3702	Describes the specifications, features, and functions of the LT140.
FUJITSU Storage ETERNUS LT140 Tape Library User's Guide -Site Planning-	P3AG-3712	Describes the onsite requirements for installation of the LT140.
FUJITSU Storage ETERNUS LT140 Tape Library User's Guide -Installation & Operation-	P3AG-3722	Describes the operation management and maintenance of the LT140.
FUJITSU Storage ETERNUS LT140 Tape Library User's Guide -Panel Operation-	P3AG-3732	Describes how to use the operator panel and the remote panel for monitoring and configuring the LT140.
FUJITSU Storage ETERNUS LT140 Tape Library Product List	P3AG-3742	Provides lists of the optional products for the LT140 and describes possible combinations.
FUJITSU Storage ETERNUS LT140 Tape Library User's Guide -Server Connection-	P3AG-3752	Describes the required settings to connect the LT140 to the server.
FUJITSU Storage ETERNUS LT140 Tape Library Key Management Function Option User's Guide	P3AG-3762	Provides an overview of the LT140 key management function option and describes the operation method.
ETERNUS LT140 License Condition List	CA08565-8630	Provides the terms and conditions of the open source licenses.

Package Contents

Check the contents in the package contents list to make sure that none of the contents for the purchased product are missing. Put a check mark in the checkbox for each item confirmed.

If there is a missing item, contact your sales representative.

- Store the package contents in a safe and secure location, as they may be needed again when making changes to the system or reinstalling the software.
- Note that the package may sometimes also contain an Errata sheet and/or other such unlisted documentation.

ETERNUS LT140 (Base Model) (Product ID: LT14AB)

- Base Module (x 1)



- Cleaning Cartridge (x 1)

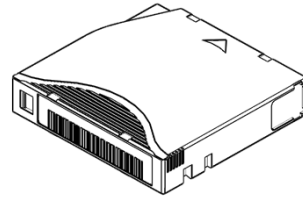

- Rack Mount Kit (x 1 set)

- Rack Rail (x 1 set)



- Repeat Tie (x 1)

- Read Me First (this document) (x 1)

- Safety Precautions (x 1)

- Rack Rail Adapter Kit (x 1 set)

- Rack Rail Adapter (x 4)

- Screw (x 4)



Expansion Module Option (Product ID: LT14AZ40)

- Expansion Module (x 1)



- Rack Rail Adapter Kit (x 1 set)

- Rack Rail Adapter (x 4)

- Screw (x 4)



- Rack Mount Kit (x 1 set)

- Rack Rail (x 1 set)



- Module Connection Cable (x 1)



LTO-6 SAS HH Drive Option -I (Product ID: LT14ASKE)

LTO-6 FC HH Drive Option -I (Product ID: LT14AFKE)

LTO-7 SAS HH Drive Option -I (Product ID: LT14ASME)

LTO-7 FC HH Drive Option -I (Product ID: LT14AFME)

LTO-8 SAS HH Drive Option -I (Product ID: LT14ASNE)

LTO-8 FC HH Drive Option -I (Product ID: LT14AFNE)

- Drive Module (x 1)

- FC Model

- SAS Model



PSU Option (Product ID: LT14AZ06E)

PSU (x 1)



Left Magazine Option (Product ID: LT14AZ20)

Left Magazine (x 1)



Right Magazine Option (Product ID: LT14AZ21)

Right Magazine (x 1)



Slot Expansion License Option (Product ID: LT14AZ03E)

License Sheet (x 1)

License Partitioning Option (Product ID: LT14AZ05E)

License Sheet (x 1)

Key Management Function Option (Product ID: LT14AZ08E)

License Sheet (x 1)

LTFS Option (Product ID: LT14AZ31)

CD (x 1)

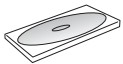

1 x 1 miniSAS HD Cable 3m (Product ID: LTCBH113)

miniSAS HD cable (x 1)

AC 100V/200V Power Cable (Product ID: LTCBP05UE)**AC 100V/200V Power Cable (Product ID: LTCBP10UE)****AC 100V/200V Power Cable (Product ID: LTCBP15UE)****AC 100V/200V Power Cable (Product ID: LTCBP30UE)****AC 100V Power Cable (Product ID: LTCBPN30UE)****AC 200V Power Cable (Product ID: LTCBPN40UE)**

AC Cable (x 1)

Notes Regarding the Handling of Tape Cartridges

Notes on Affixing Tape Cartridge Labels

Tape cartridge labels that get loose or get into the drive may cause failures such as a backup operation suspension. To ensure stable system operation, cartridge labels must be handled with care.

- Beware of loose labels

If the label on the tape cartridge gets loose, the label may cause a failure by sticking to the robot mechanisms of the tape library or to the tape drive.

Note the following points when affixing the labels.

- Make sure to use the blank labels provided with the tape cartridge or barcode labels that are recommended by Fujitsu.
- Keep the surface clean and free of fingerprints or dirt.
- Attach the label firmly on the specified location so that the label is affixed smoothly without any wrinkles.
- Do not affix a new label over the old one. Make sure to peel off the old label and clean the surface before affixing the new label.

Important Be careful since the corners of the labels are prone to getting loose.

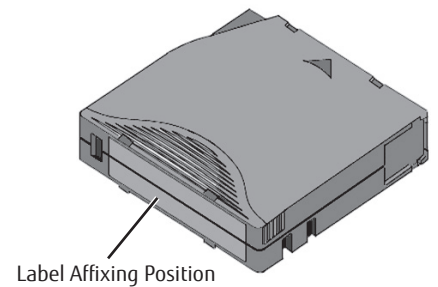

- Beware of the label sheet getting into the tape drive

The blank label sheet may be on top or below the tape cartridge.

The label sheet may cling to the tape cartridge due to static.

If the tape cartridge is inserted into the library device in this condition, a failure may occur.

When using a new tape cartridge, make sure that the label sheet is not clinging to the tape cartridge.

Important Note that you may miss the label sheet if it is enclosed below the tape cartridge.

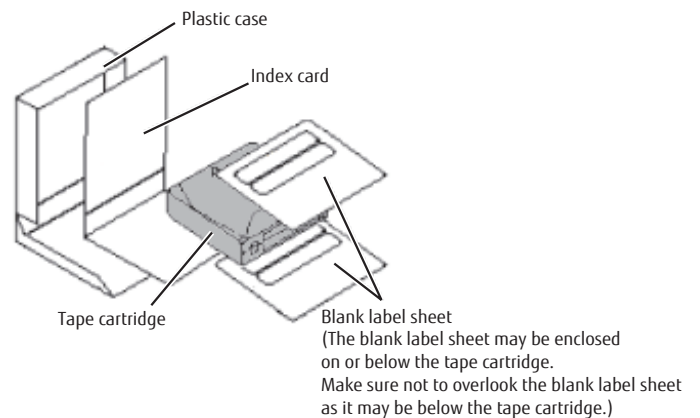

Cleaning the Tape Drives

To maintain stable system operation, the tape drive must be cleaned. Perform regular cleanings.

Sticky debris generated from magnetic tapes and dust entering the device may become attached to the magnetic head of the tape drive causing errors and failures.

To maintain stable system operation, dust and debris must be cleaned on a regular basis.

In addition, cleaning cartridges can only be used a limited number of times. If the maximum number is reached, replace the cleaning cartridge.

The following table shows a guideline for the cleaning cycle and the number of cleanings that can be performed.

Standard cleaning cycle	Number of times the cleaning cartridge can be used
Whichever of the following occurs first <ul style="list-style-type: none"> • Every three months • Every 1,000 mounts • When a device cleaning is requested 	Approximately 50 times

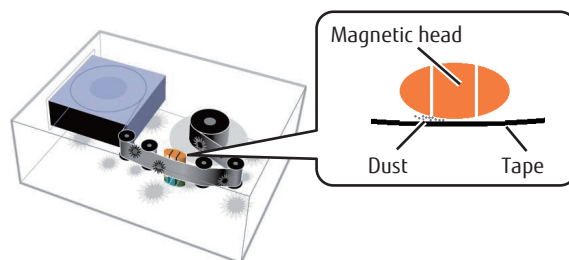

(Reference) Tape Storage Technical Committee

Managing the service life of tape cartridges

Tape cartridges are consumable goods.

Tape cartridges must be replaced on a regular basis to maintain stable backup operation.

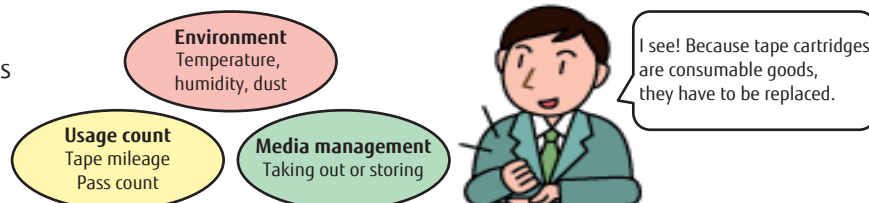

The lifespan of a tape cartridge varies depending on the usage environment, the number of times used, and the operation of the media, and it cannot be defined clearly. However, as the usage increases, the surface of the tape cartridge becomes damaged and the head becomes dirty causing an increase in read and write errors.

Therefore, replacing the tape cartridges on a regular basis as described in the terms below is recommended.

Important The following condition is assumed that the tape cartridges are used correctly in the proper environment.

Replacement guideline for tape cartridges	Tape cartridge storage environment
If a tape cartridge is used in backup operations for one year or 1000 times, whichever comes first.	Temperature: 16 to 32 °C Humidity: 20 to 80% RH Other: keep the tape cartridges free of moisture and condensation by placing them in the specialized cases, do not leave them in direct sunlight or in dusty environments, and do not put them near power cables, motors, or power supplies.

Related Constitutions

- **Applicable Environment**

The LT140 was designed and manufactured for general office use, with user safety in mind. When using the LT140, follow the handling instructions, and the placement and cautionary notes listed in the manuals. If used beyond the limits described, the users may be at risk of personal injury and/or material damage.

- **Using the Manuals**

The manuals for the LT140 contain important information regarding safe usage.

Please read the manuals carefully before using the LT140. Pay special attention to "FUJITSU Storage ETERNUS LT140 Tape Library Safety Precautions", and understand the contents thoroughly before connecting.

Keep the manuals in a safe place for future reference.

Fujitsu pays careful attention to the safe use of its products to prevent user injury and/or material damage. To use the LT140 properly, please follow the instructions in the manuals.

- **Maintenance**

Do not attempt to repair the LT140 by yourself. Ask Fujitsu to dispatch one of its maintenance engineers or a maintenance engineer authorized by Fujitsu for maintenance work.

Note that our maintenance engineer may connect maintenance equipment (such as PCs) in order to diagnose the LT140.

Maintenance engineers use one of the following connection for maintenance.

- Connection between an LT140 and a customer's PC via a network

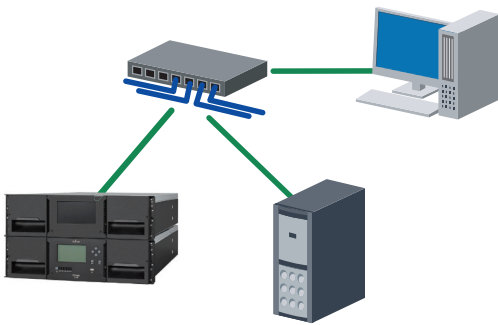

- Direct connection between an LT140 and a customer's PC



- Direct connection between an LT140 and a management PC (FST)



- **Compliance Standards**

Product safety	UL60950-1, CAN/CSA C22.2 No. 60950-1, EN60950-1, IEC60950-1
Electromagnetic Compatibility	CNS13438 (C6357) Class A, FCC CFR47 part 15 Class A, ICES-003 Class A, EN55032 Class A, VCCI Class A, AS/NZS CISPR32 Class A
Electromagnetic Immunity	EN55024
CE certification	Electromagnetic Compatibility Directive 2014/30/EU Low Voltage Directive 2014/35/EU
Environmental compliance	RoHS-compliant (Restriction of the use certain hazardous substances) 2011/65/EU WEEE-compliant (Waste electrical and electronic equipment)

- **Terms and conditions**

The product includes software provided by third parties. The use of third party software is subject to the terms and conditions stated in the "ETERNUS LT140 License Condition List" section of the following website.

<http://www.fujitsu.com/global/support/products/computing/storage/tape/manuals/>

If you have any questions concerning source code or documents of the software that the terms and conditions are applied, please email to tp-ltsupport@ml.css.fujitsu.com.

This Product is designed, developed and manufactured as contemplated for general use, including without limitation, general office use, personal use, household use, and ordinary industrial use, but is not designed, developed and manufactured as contemplated for use accompanying fatal risks or dangers that, unless extremely high safety is secured, could lead directly to death, personal injury, severe physical damage or other loss (hereinafter "High Safety Required Use"), including without limitation, nuclear reaction control in nuclear facility, air craft flight control, air traffic control, mass transport control, medical life support system, missile launch control in weapon system. You shall not use this Product without securing the sufficient safety required for the High Safety Required Use. If you wish to use this Product for High Safety Required Use, please consult with our sales representatives in charge before such use.

The following notice is for EU users only.

WARNING: This is a product which meets Class A of EN55022. In a domestic environment this product may cause radio interference in which case the user may be required to take adequate measures.

The following notice is for USA users only.

This equipment has been tested and found to comply with the limits for a Class A digital device, pursuant to Part 15 of the FCC Rules. These limits are designed to provide reasonable protection against harmful interference when the equipment is operated in a commercial environment. This equipment generates, uses, and can radiate radio frequency energy and, if not installed and used in accordance with the instruction manual, may cause harmful interference to radio communications. Operation of this equipment in a residential area is likely to cause harmful interference in which case the user will be required to correct the interference at his own expense.

Laser Standard

The Fibre Channel printed circuit board contains a laser system (GBIC or GLM module). Laser systems are classified as Class I Laser Equipment by the radiation standards of the Department of Health and Human Services (DHHS) in accordance with Radiation Control for Health and Safety Act of 1968 and also based on the safety requirements for laser products in EN60825-1 (+All). The certificate of conformance is affixed to the module.

● Simplified Chinese

电子信息产品生产者 (生產者): FUJITSU LIMITED

电子信息产品安全使用期限



此标记是按照2006年2月28日公布的[电子信息产品污染控制管理办法]以及SJ/T 11364-2006[电子信息产品污染控制标识要求]在中国销售的电子信息产品的环保使用期限。如遵守关于这产品的安全或使用上的注意,在这期限内(从生产日期起算)不会因产品中的有害物质漏到外部、或发生突然变异,而引起环境污染和对人体或财产的重大影响。

有毒有害物质元素名称及其含量及部件

部件名称	有害物质					
	铅 (Pb)	汞 (Hg)	镉 (Cd)	六价铬 (Cr (VI))	多溴联苯 (PBB)	多溴二苯醚 (PBDE)
机箱 底盘	○	○	○	○	○	○
印刷线路板	○	○	○	○	○	○
电源	○	○	○	○	○	○
风扇机、电动机	○	○	○	○	○	○
面板	○	○	○	○	○	○
磁带驱动器	×	○	○	○	○	○

本表格依据SJ/T11364 的规定编制

○: 表示该有害物质在该部件所有均质材料中的含量均在GB/T26572 规定的限量要求以下。

×: 表示该有害物质至少在该部件的某一均质材料中的含量超出GB/T26572 规定的限量要求。

● Traditional Chinese

台灣 RoHS

限用物質含有情況標示

單元 Unit	限用物質及其化學符號 Restricted substances and its chemical symbols					
	鉛Lead (Pb)	汞 Mercury (Hg)	鎘 Cadmium (Cd)	六價鉻 Hexavalent chromium (Cr ⁺⁶)	多溴聯苯 Polybrominated biphenyls (PBB)	多溴二苯醚 Polybrominated diphenyl ethers (PBDE)
外殼	○	○	○	○	○	○
印刷電路板	○	○	○	○	○	○
電源供應器	○	○	○	○	○	○
馬達	○	○	○	○	○	○
面板	○	○	○	○	○	○
磁帶驅動器	—	○	○	○	○	○

備考1. “○” 係指該項限用物質之百分比含量未超出百分比含量基準值。

Note 1: “○” indicates that the percentage content of the restricted substance does not exceed the percentage of reference value of presence.

備考2. “—” 係指該項限用物質為排除項目。

Note 2: The “—” indicates that the restricted substance corresponds to the exemption.

警告使用者:

這是甲類的資訊產品, 在居住的環境中使用時, 可能會造成射頻干擾, 在這種情況下, 使用者會被要求採取某些適當的對策。

FUJITSU Storage ETERNUS LT140 Tape Library
Read Me First
P3AG-3692-01EN
Date of issuance: December 2018
Issuance responsibility: FUJITSU LIMITED

- The content of this manual is subject to change without notice.
- This manual was prepared with the utmost attention to detail. However, Fujitsu shall assume no responsibility for any operational problems as the result of errors, omissions, or the use of information in this manual.
- Fujitsu assumes no liability for damages to third party copyrights or other rights arising from the use of any information in this manual.
- The content of this manual may not be reproduced or distributed in part or in its entirety without prior permission from Fujitsu.